

CD45

DMX512 Four Channel Dimmer and Switch module

Input: 8 Amps @ 7-24 VDC
Outputs: 4 x 5 Amps Maximum each ;
Total of 4 outputs 8 Amps Maximum.



USER'S MANUAL



GENERAL DESCRIPTION

The CD45 is a CD400-DMX module in an enclosure

The **CD400-DMX** is a 4-channel DMX-512 compatible dimmer pack. It is equivalent to four solid-state relays (SSR's) and a DMX512 Logic assembled on a single circuit board. Power is fed to the **CD400-DMX** from **One 8 Amps power supply @ volatges ranging from 7 VDC to 24VDC..** Each solid state relay is rated for a maximum output current of **5 Amps.** (Total of 4 loads current not to exceed 8 Amps.) The **CD400-DMX** is sold as a PC board assembly without enclosure. The logic signals are optically-isolated from the output voltage.

DMX-512 control cable is hardwired to the **CD400-DMX.** Several Dimmer packs may be daisy-chained together. Each **CD400-DMX** may be easily set to a unique address with 2 hexadecimal selectors and will occupy the next four DMX control channels beginning with the one following the address selected. When two or more units are set to the same address, their respective outputs work in unison, increasing the amount of load that can be controlled by a single DMX channel.

Figure 1 shows components details of the **CD400-DMX.** Figure 2 shows a functional block diagram ; Figure 5 shows **CD400-DMX** dimmers in a typical installation.

DIMMING/SWITCHING -

A **CD400-DMX** may control a combination of dimmed and switched loads.

Figure 1 - CD400-DMX block diagram:

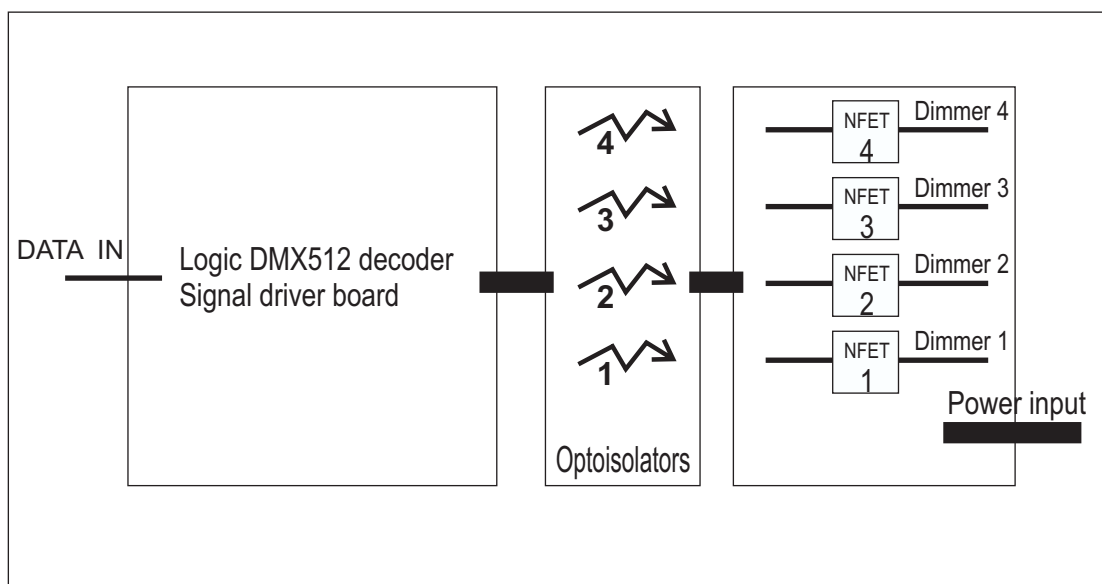



CD400-DMX Module Detail

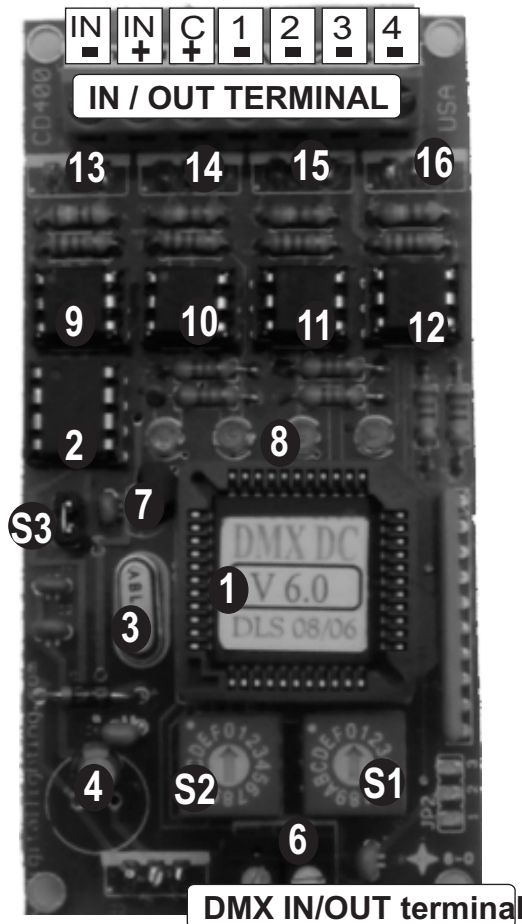

FRONT

Figure 2 -
CD400-DMX
Detail

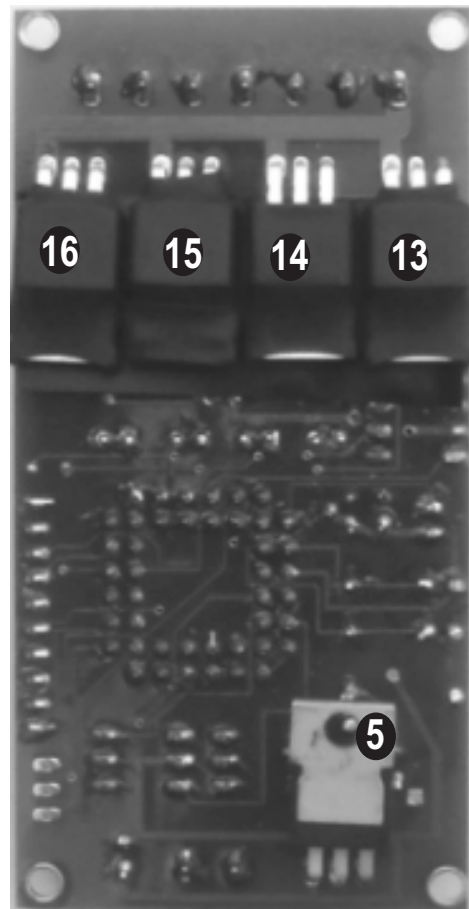

BACK

Table 1 - OUTPUT Terminals Definition

NAME	DESCRIPTION
1	Output Of Solid-State Relay #1
2	Output Of Solid-State Relay #2
3	Output Of Solid-State Relay #3
4	Output Of Solid-State Relay #4
C +	Common positive
IN +	Positive Feed For Relays 1 , 2 , 3 & 4.
IN -	Negative Feed For Relays 1 , 2 , 3 & 4.

Table 2 - Maximum Electrical Ratings

Electrical Characteristic	Terminal	Maximum
Load Current	1 to 4	5Amps.Max
Input Current	DC	8 Amps.Max
Input Voltage	H	7-24 VDC

Table 3 - CD400-DMX Circuit Legend

1	Microprocessor.
2	Communications Chip.
3	Quartz Crystal.
4	Power Supply Capacitor.
5	Voltage Regulator.
6	DMX512 DATA connector.
7	Auto reset +/- 5%
8	Output LED Monitors.
9,10,11,12	Optical Couplers # 1,2,3,4
13,14,15,16	Mosfets # 1,2,3,4
S1-S2	Address Selectors.
S3	Hi address Jumper (257 to 512)

Mechanical Installation

The **CD45 Pack** is designed to be surface mounted



Dimensions: 4.50" x 2.20" x 1.25"
Mounting Holes 4.00 inch on center

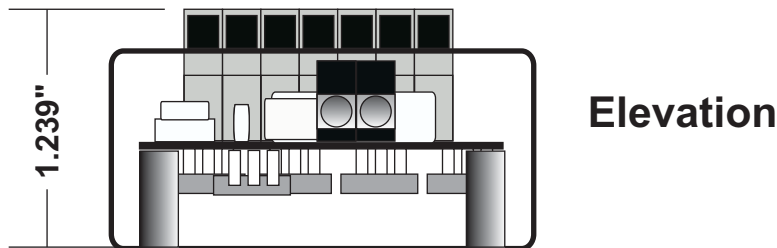

Figure 3 - CD45 Dimensional Diagram

CD45 Signal Wiring Methods

Figure 4
CD Dimmer DMX512 signal Connections.

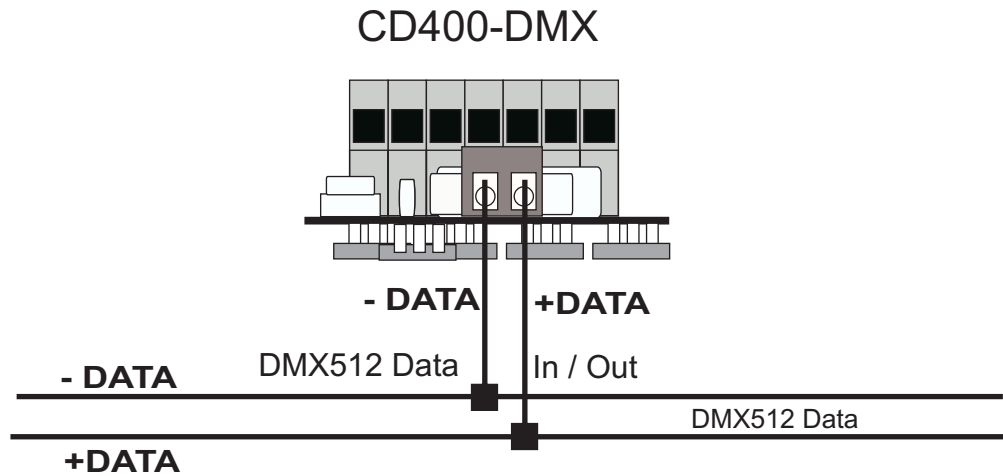

Figure 5 - Typical Installation

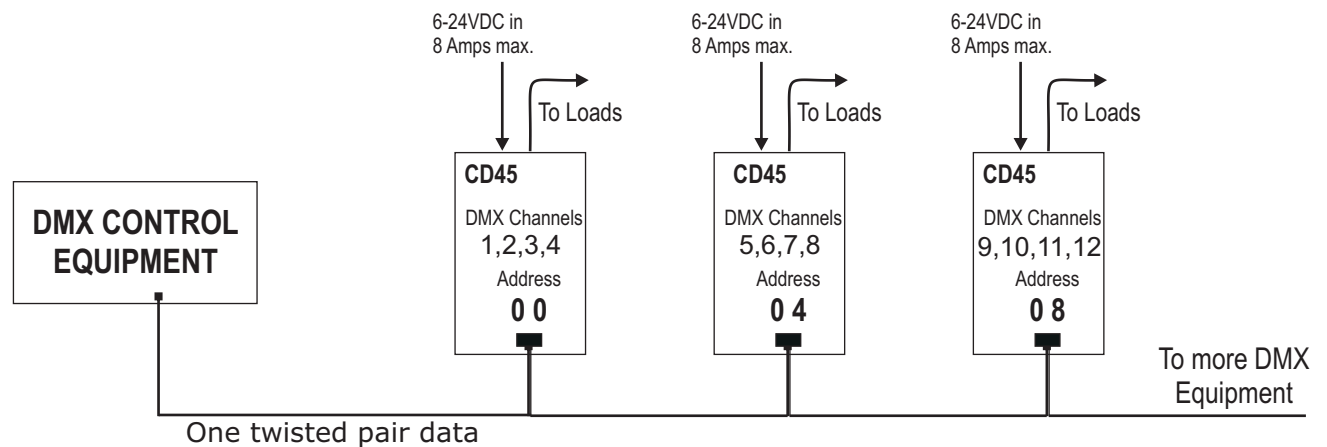
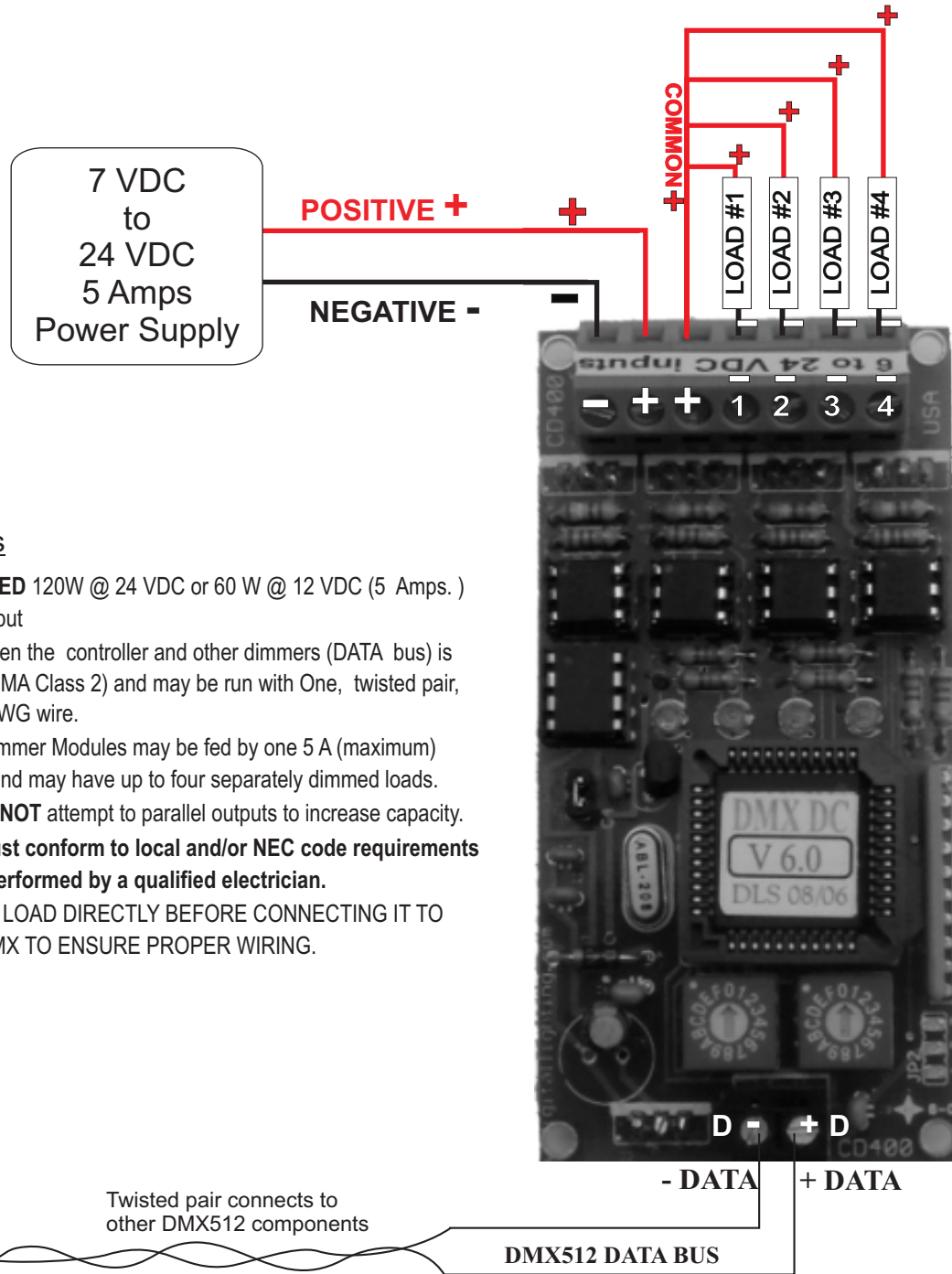

Figure 6 - Cd45 GENERAL WIRING INSTRUCTIONS:



Wiring Notes

- ❑ **DO NOT EXCEED** 120W @ 24 VDC or 60 W @ 12 VDC (5 Amps.) per dimmer output
- ❑ All wiring between the controller and other dimmers (DATA bus) is low voltage (NEMA Class 2) and may be run with One, twisted pair, shielded #22 AWG wire.
- ❑ **CD400-DMX** dimmer Modules may be fed by one 5 A (maximum) power supply and may have up to four separately dimmed loads.
- ❑ **CAUTION: DO NOT** attempt to parallel outputs to increase capacity.
- ❑ **Installation must conform to local and/or NEC code requirements and must be performed by a qualified electrician.**
- ❑ **POWER EACH LOAD DIRECTLY BEFORE CONNECTING IT TO THE CD400-DMX TO ENSURE PROPER WIRING.**

NOTES

- 1 Follow Power supply installation & wiring instructions from manufacturer.
- 2 Maximum Load Per Output: 5 Amps.
- 3 Maximum total loads on four outputs : 8 Amps.



DMX Address Setting

Up to 128 CD400-DMX dimmer packs may be installed per system and their DMX input daisy-chained using standard DMX-512 cables. Different addresses ranging from 1 to 509 may be selected for each dimmer, depending on which DMX channel(s) will be used to control it. Each dimmer pack uses four consecutive DMX bytes from the input stream beginning at the address selected using rotary selectors S1, S2 and address expansion jumper S3. (See Figure 2 on page 2 for selectors location).

The CD400-DMX is shipped from the factory with jumper S3 installed allowing a DMX address range between 1 and 256 to be selected by S1 & S2 (See Table 4). For higher addresses (257-509) jumper S3 must be removed (See Table 5).

Figure 7 - Cd45 Address Selection.

Open cover to access to jumper (S3)

Address Jumper (S3)

When **S3** Jumper is Installed
(**S2,S1**) Address Range: 1-256

When **S3** Jumper is Removed
(**S2,S1**) Address Range: 257-509

Unit is shipped with **S3** Installed.

High address
257 to 509
Jumper

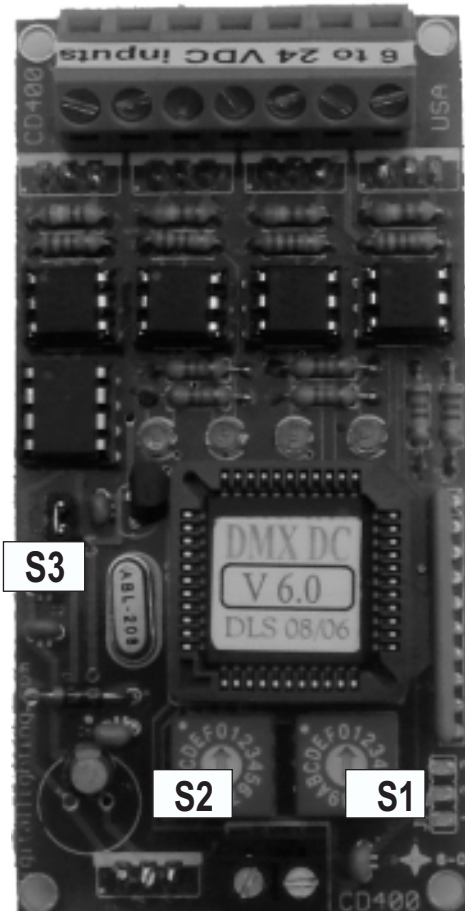

CD400-DMX Installation Check List

BEFORE ENERGIZING THE CD400-DMX MAKE SURE:

- Loads are tested before connecting to dimmers.
- All screw terminals are properly tightened to prevent hot spots.
- Low voltage data lines connections are properly insulated.
- Low voltage data lines polarity is observed throughout the system.
- The CD400-DMX is set to the right address.



CD400-DMX Address Selection Information

Table 4 - Addresses 1-256

Cha. Addr.	Select S2 S1	Cha. Addr.	Select S2 S1	Cha. Addr.	Select S2 S1	Cha. Addr.	Select S2 S1	Cha. Addr.	Select S2 S1	Cha. Addr.	Select S2 S1	Cha. Addr.	Select S2 S1	Cha. Addr.	Select S2 S1
1	00	33	20	65	40	97	60	129	80	161	A0	193	C0	225	E0
2	01	34	21	66	41	98	61	130	81	162	A1	194	C1	226	E1
3	02	35	22	67	42	99	62	131	82	163	A2	195	C2	227	E2
4	03	36	23	68	43	100	63	132	83	164	A3	196	C3	228	E3
5	04	37	24	69	44	101	64	133	84	165	A4	197	C4	229	E4
6	05	38	25	70	45	102	65	134	85	166	A5	198	C5	230	E5
7	06	39	26	71	46	103	66	135	86	167	A6	199	C6	231	E6
8	07	40	27	72	47	104	67	136	87	168	A7	200	C7	232	E7
9	08	41	28	73	48	105	68	137	88	169	A8	201	C8	233	E8
10	09	42	29	74	49	106	69	138	89	170	A9	202	C9	234	E9
11	0A	43	2A	75	4A	107	6A	139	8A	171	AA	203	CA	235	EA
12	0B	44	2B	76	4B	108	6B	140	8B	172	AB	204	CB	236	EB
13	0C	45	2C	77	4C	109	6C	141	8C	173	AC	205	CC	237	EC
14	0D	46	2D	78	4D	110	6D	142	8D	174	AD	206	CD	238	ED
15	0E	47	2E	79	4E	111	6E	143	8E	175	AE	207	CE	239	EE
16	0F	48	2F	80	4F	112	6F	144	8F	176	AF	208	CF	240	EF
17	10	49	30	81	50	113	70	145	90	177	B0	209	D0	241	F0
18	11	50	31	82	51	114	71	146	91	178	B1	210	D1	242	F1
19	12	51	32	83	52	115	72	147	92	179	B2	211	D2	243	F2
20	13	52	33	84	53	116	73	148	93	180	B3	212	D3	244	F3
21	14	53	34	85	54	117	74	149	94	181	B4	213	D4	245	F4
22	15	54	35	86	55	118	75	150	95	182	B5	214	D5	246	F5
23	16	55	36	87	56	119	76	151	96	183	B6	215	D6	247	F6
24	17	56	37	88	57	120	77	152	97	184	B7	216	D7	248	F7
25	18	57	38	89	58	121	78	153	98	185	B8	217	D8	249	F8
26	19	58	39	90	59	122	79	154	99	186	B9	218	D9	250	F9
27	1A	59	3A	91	5A	123	7A	155	9A	187	BA	219	DA	251	FA
28	1B	60	3B	92	5B	124	7B	156	9B	188	BB	220	DB	252	FB
29	1C	61	3C	93	5C	125	7C	157	9C	189	BC	221	DC	253	FC
30	1D	62	3D	94	5D	126	7D	158	9D	190	BD	222	DD	254	FD
31	1E	63	3E	95	5E	127	7E	159	9E	191	BE	223	DE	255	FE
32	1F	64	3F	96	5F	128	7F	160	9F	192	BF	224	DF	256	FF

Table 4 - **CD400-DMX** Decimal to Hexadecimal Address Chart.

Address Selection Chart Using S2-S1 with **JUMPER 3 INSTALLED**



CD400-DMX Address Selection Information
Table 5 - Addresses 257-509

Cha. Addr.	Select S2 S1	Cha. Addr.	Select S2 S1	Cha. Addr.	Select S2 S1	Cha. Addr.	Select S2 S1	Cha. Addr.	Select S2 S1	Cha. Addr.	Select S2 S1	Cha. Addr.	Select S2 S1	Cha. Addr.	Select S2 S1
257	00	289	20	321	40	353	60	385	80	417	A0	449	C0	481	E0
258	01	290	21	322	41	354	61	386	81	418	A1	450	C1	482	E1
259	02	291	22	323	42	355	62	387	82	419	A2	451	C2	483	E2
260	03	292	23	324	43	356	63	388	83	420	A3	452	C3	484	E3
261	04	293	24	325	44	357	64	389	84	421	A4	453	C4	485	E4
262	05	294	25	326	45	358	65	390	85	422	A5	454	C5	486	E5
263	06	295	26	327	46	359	66	391	86	423	A6	455	C6	487	E6
264	07	296	27	328	47	360	67	392	87	424	A7	456	C7	488	E7
265	08	297	28	329	48	361	68	393	88	425	A8	457	C8	489	E8
266	09	298	29	330	49	362	69	394	89	426	A9	458	C9	490	E9
267	0A	299	2A	331	4A	363	6A	395	8A	427	AA	459	CA	491	EA
268	0B	300	2B	332	4B	364	6B	396	8B	428	AB	460	CB	492	EB
269	0C	301	2C	333	4C	365	6C	397	8C	429	AC	461	CC	493	EC
270	0D	302	2D	334	4D	366	6D	398	8D	430	AD	462	CD	494	ED
271	0E	303	2E	335	4E	367	6E	399	8E	431	AE	463	CE	495	EE
272	0F	304	2F	336	4F	368	6F	400	8F	432	AF	464	CF	496	EF
273	10	305	30	337	50	369	70	401	90	433	B0	465	D0	497	F0
274	11	306	31	338	51	370	71	402	91	434	B1	466	D1	498	F1
275	12	307	32	339	52	371	72	403	92	435	B2	467	D2	499	F2
276	13	308	33	340	53	372	73	404	93	436	B3	468	D3	500	F3
277	14	309	34	341	54	373	74	405	94	437	B4	469	D4	501	F4
278	15	310	35	342	55	374	75	406	95	438	B5	470	D5	502	F5
279	16	311	36	343	56	375	76	407	96	439	B6	471	D6	503	F6
280	17	312	37	344	57	376	77	408	97	440	B7	472	D7	504	F7
281	18	313	38	345	58	377	78	409	98	441	B8	473	D8	505	F8
282	19	314	39	346	59	378	79	410	99	442	B9	474	D9	506	F9
283	1A	315	3A	347	5A	379	7A	411	9A	443	BA	475	DA	507	FA
284	1B	316	3B	348	5B	380	7B	412	9B	444	BB	476	DB	508	FB
285	1C	317	3C	349	5C	381	7C	413	9C	445	BC	477	DC	509	FC
286	1D	318	3D	350	5D	382	7D	414	9D	446	BD	478	DD	510	N/A
287	1E	319	3E	351	5E	383	7E	415	9E	447	BE	479	DE	511	N/A
288	1F	320	3F	352	5F	384	7F	416	9F	448	BF	480	DF	512	N/A

Table 5 - **CD400-DMX** Decimal to Hexadecimal Address Chart.
Address Selection Chart Using S2-S1 with JUMPER 3 REMOVED

+

LIMITED WARRANTY

Digital Lighting Systems, warrants to the purchaser that its products have been carefully manufactured and inspected and are warranted to be free from defects of workmanship and materials when used as intended. Any abuse or misuse contrary to normal operation shall void this warranty.

Digital Lighting Systems' obligation under this warranty shall be limited to replacement or repair of any units as shall within two years of date of invoice from **Digital Lighting Systems**, prove defective; and **Digital Lighting Systems** shall not be liable for any other damages, whether direct or consequential. **The implied warranties of merchantability and fitness for a particular purpose are limited to the duration of the expressed warranty.** Some states do not allow the exclusion of the limitation of incidental or consequential damages, so the above limitation or exclusion may not apply to you. This warranty gives you specific legal rights, you may also have other legal rights which vary from state to state.

Defective merchandise may be returned to **Digital Lighting Systems**, prepaid, after prior notification has been given and approval obtained for the return. To obtain prior approval for the return of the defective items, contact your local Digital Lighting Systems distributor, representative, or:

Digital Lighting Systems, Inc.

Attn: Customer Service Department
12302 SW 128 Ct. Bay #105
Miami, FL 33186
(305) 969-8442

Upon request, replacement unit(s) will be shipped as soon as available. Unless immediate shipment of replacement merchandise is requested, **Digital Lighting Systems** will not ship replacement merchandise until defective merchandise is received, inspected, and determined to be defective.

No labor charges in connection with warranty problems will be reimbursed by Digital Lighting Systems without prior written approval from the factory.

Digital Lighting Systems distributors and representatives have no authority to change this warranty without written permission.

Digital Lighting Systems reserves the right to determine the best method of correcting warranty problems.



Digital Lighting Systems, Inc.
12302 SW 128 Ct. Bay #105
Miami, FL 33186
www.digitallighting.com

Tel 305-969-8442
Fax 305-969-8675
e-m info@digitallighting.com

Printed in U.S.A.09/2020

+